

# AP Physics - Static Electricity

**History:** Electricity was first described (that we know of) by an ancient Greek, the philosopher Thales (640? - 546 B.C.E.) in the 580's B.C. What Thales noted was that when he rubbed a chunk of amber with a piece of cloth, the amber would attract small bits of stuff – fibers, dust bunny bits, fluff, &tc. The word for amber in Greek, *elektron*, gave its name to the phenomenon. Thales didn't do much with the idea which, truthfully, isn't all that exciting to begin with, so the thing sort of languished around for a very long time.

We now make a giant time shift leap type thingee to the 17th century. To 1600 to be specific. It was in this year that the English physician and physicist William Gilbert, having begun to play around with the attractive force of electricity found other substances that could be charged up besides amber. He divided materials up into classes. The classes were:

**Electrics** - stuff that gains charge and can attract things when rubbed.

**Nonelectrics** - stuff that doesn't gain a charge.

Electrics were materials like glass, amber, silk, and rubber. Nonelectrics were mostly metals

In the 1660's, the German physicist Otto von Guericke build the first static electric charging machine. He took a large ball of sulfur and rigged it so he could rotate it with a crank. As the ball rotated he pressed a piece of leather against it and the ball would gain an electric charge. Later he built an improved machine that used a glass globe. He used the machine to generate large sparks.

At this time, electricity was thought to be a fluid. They also thought that fire was a fluid, so electricity was commonly called "electric fire".

Guericke also discovered that static electricity could both be attractive and repulsive.

Around 1709 Francis Hauksbee, a British Scientist, began to experiment with Guericke's machine. In one of his experiments, he placed a small amount of mercury inside the globe. He cranked the machine in the standard way. When he touched the surface of the globe with his hand, the globe gave off a flash of light.

In 1729 Stephen Gray, an English physicist, found cork acted as a **conductor**. A conductor is a substance that allows charge to travel through it. This introduced the idea that there were materials that were conductors and materials that were **insulators**. Turns out that conductors are Gilbert's nonelectrics and insulators are the electrics. Insulators stop the flow of charge.

In 1733 Charles Du Fay, a French physicist, discovered that there were two types of electric charge. He found that the charge on a glass rod was different than the charge on a piece of amber. He named the charge on a glass rod **vitreous** electricity. The electricity on the amber was called **resinous** electricity.

In the 1740's, Benjamin Franklin, the famous American printer and founding father, found that the vitreous electric charge could cancel out the resinous electric charge. He also came up with the names we use today for the differing charges, positive and negative charge.

***Electric Basics:*** Electricity is an aspect of one of the four fundamental forces in the universe, the electromagnetic force. It involves attraction and repulsion between charged particles. The source of the charge is two subatomic particles, the electron and the proton. Electrons have a negative charge and protons have a positive charge. The magnitude of the charge is the same for each particle. We say that an electron has a charge of “minus one” or  $-1$ . The proton has charge of “plus one” or  $+1$ . All this minus one or plus one stuff is mainly a chemistry thing. In physics we use a different unit for charge, as we shall see.

Atoms are electrically neutral – they have no charge. This is because they have the same number of electrons as protons and their charges cancel each other out. If an atom gains or loses electrons, it gains a charge and becomes an ***ion***. We say it is ***ionized***. Ions are a really big deal in chemistry, but not much of a thing in physics.

Different elements vary widely in their ability to gain or lose electrons. This is what is involved when you rub an object with a cloth to give it a charge. You blow up a rubber balloon and rub it with a bit of wool. The balloon is more attractive to electrons than is the cloth, so during the rubbing, electrons from the cloth jump onto the balloon. This gives the balloon a negative charge because it now has more electrons than protons. The cloth gains a positive charge (it has more protons than electrons so the net charge is positive). Rubber objects almost always gain a negative charge during rubbing operations.

A glass rod rubbed with silk will gain a positive charge.

Rubber and glass rods are often used in experiments to establish known charges for use in comparison tests.

The generation of charge by friction is called ***triboelectricity***. Isn't it wonderful how physics has phancy names for everything?

Charged objects exert forces on one another and obey the fundamental law of static electricity:

***Fundamental Law of Static Electricity = Like charges repel; opposite charges attract.***

Two balloons that have been given a negative charge will repel each other. A negatively charged object will attract a positively charged object.

Here's another key concept, the principle of conservation of charge.

***Principle of Conservation of Charge = charge is not created or destroyed, merely transferred from one system to another.***

### ***Back to Insulators and Conductors:***

Conductors are usually metals. The charge is carried through the material by the free electrons that metals have because of their metallic bonds.

Insulators are non-metals; materials like plastic, rubber, ceramics, &tc. These substances have their electrons tightly bound in their chemical bonds. The charge can't go anywhere in these substances because there's nothing to carry the charge. The electrons are not free to move, don't you see. When a charge is placed on an insulator, the charge stays where you put it. When a charge is placed on a conductor it will immediately spread out over the entire object (actually, as we shall see, it travels to the outer surface of the conductor).

**Electrolytes** are liquid solutions that can conduct electricity. The electrolyte contains ions that transfer charge.

**Charging Objects:** There are two methods that can be used to charge objects; **charging by conduction** and **charging by induction**.

Charging by conduction is very simple. An object is given a charge – we rub a rubber rod with a rabbit fur. The rod now has a negative charge. We also have a metal sphere attached to an insulated stand. We touch the sphere with the charged rod and some of the extra electrons on the rod will flow onto the sphere, giving it a negative charge. A common way to transfer charge by conduction is through the use of a small metal disc attached to an insulated rod. This device is called a **proof plane** (the Physics Kahuna has no idea why). When it is touched to a charged object it gains the same charge by conduction. This charge can then be transferred to some other object or tested.

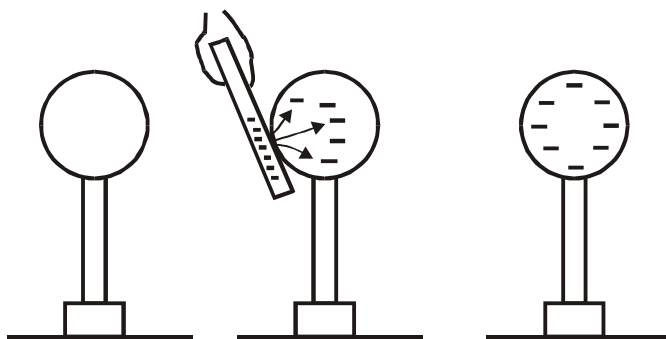

**Charging by Conduction**

Charging by induction is a bit more complicated. We start out with a charged object and an uncharged object. Charge is transferred, but there is no physical contact between the two objects.

There are two ways to do this. Let's look at the first method. We have a negatively charged rubber rod and an insulated metal sphere. You cannot charge an insulator by induction, the method works only with objects that have conductive surfaces.

1. Bring the charged object near the insulated sphere. The sphere is electrically neutral – same number of electrons as protons, duh. The negative charge on the rod will repel the free electrons on the sphere's surface, however. They will collect on the opposite side of the sphere from the rod - they're trying to get as far away from the negative charge on

the rod as they can. Remember, in a conductor, they are free to move about. If the charged rod is moved away from the sphere, the electrons will redistribute themselves over the surface and the sphere will remain electrically neutral. With the charged rod near, the sphere is **polarized** – one side has a positive charge and the other side has a negative charge. Even though the net charge on the object is still zero, so the thing is still electrically neutral.

2. Keeping the charged rod near the sphere (but not touching it) touch the opposite side of the sphere with a finger. This will “ground” the sphere. The electrons, wanting to get away from the negative charge on the rod (like objects repel) will flow into your finger. This is because you are a big electron sink that the electrons can go into. The earth is an even bigger sink, so anytime electrons are given a path to travel into a big sink we say they have been “grounded”. The big sink is a “ground”.
3. Take the finger away and remove the rod.
4. The sphere, having lost a good many of its electrons, will now have a positive charge. It is positive because there are more protons than electrons. It has been **charged by induction**.

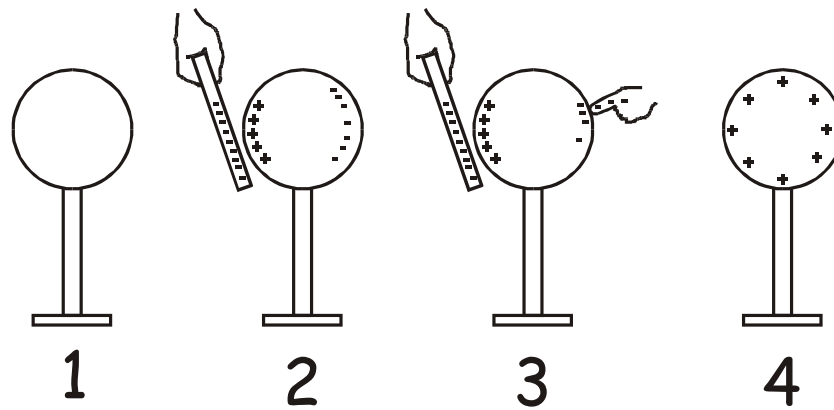

The second induction method involves two insulated objects.

1. Place the two objects in physical contact with one another – they must touch. In this example we have two insulated conductive spheres. These are metal spheres on insulated stands.
2. Bring a charged object to the side of one of the spheres. Don’t touch the sphere; just bring the object nearby. In this example we have a negatively charged rubber rod.

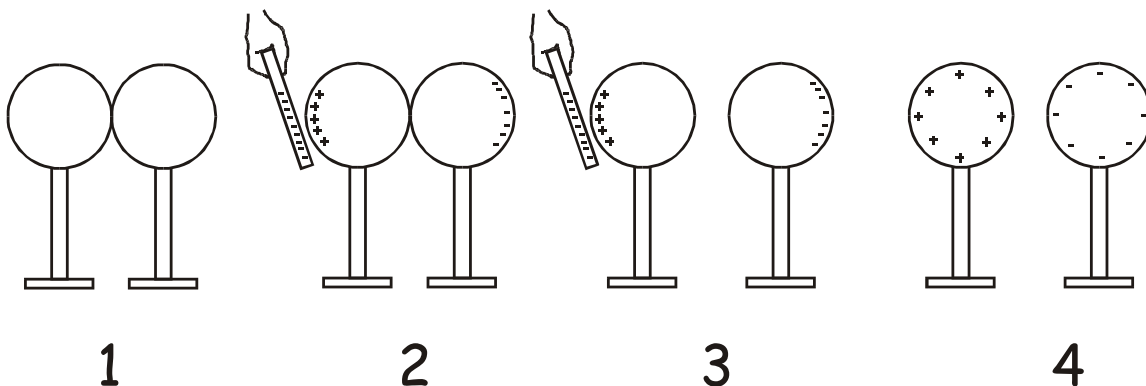

Electrons in the first sphere, the one near the charged rod, are repelled and will move into the second sphere. They try to get as far away from the rod as possible. As long as the rod near one of the spheres, the two sphere system will be polarized.

3. Move the sphere opposite of the one near the charged rod away from the other sphere so they no longer touch. The sphere you moved will have an excess of electrons, the ones from the other sphere, and will have a negative charge. The other sphere, having lost some of its electrons, will have a positive charge.
4. Pull the rod away. The two spheres are now charged – **charged by induction!**

**Polarizing Objects:** Briefly mentioned in the explanation of charging by induction was the term “polarized”. Polarizing is important in many of the electrostatic phenomenon that we have played around with. For example, why did the rubber rod attract bits of paper? The rubber rod had a charge, but the paper bits did not, they were quite neutral, wasn’t they? Why did the charged balloon stick to a person’s clothing or the wall? Why was the 2 x 4 attracted to the charged PVC pipe?

These things happen because of polarization. When you bring a charged object near an uncharged object, the uncharged object gets polarized. Think of the molecules that make up the uncharged object. The molecule has no charge. But when the charged rod comes near it, electrons are either attracted or repelled toward the rod. This motion happens because of the nature of the covalent bond, you know, the old “sharing of electrons” thing. So the electrons try to get away from a negatively charged object, or they are attracted to a positively charged object. The net effect is to cause the molecules to have a positive side and a negative side, even though overall it is electrically neutral. As long as the charged object is nearby, the molecule stays polarized.

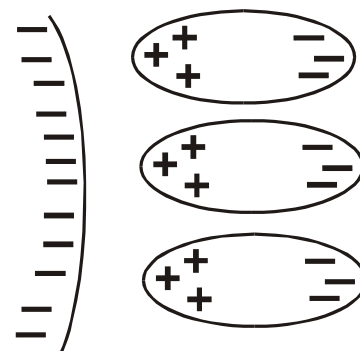

### ***Polarized Molecules***

The charged balloon sticks to the wall because it polarizes the molecules in the wall and the negative charge of the balloon is attracted to the positive end of the wall’s molecules.

**Sparks:** One of the things you will have observed is that when a charge goes from one object to another, it can travel through the air in the form of a spark. Sparks can be barely noticeable or they can be so massive that it is impossible to ignore them, like a lightning bolt.

The bigger the charge difference between two objects, the more the charge wants to move. If the charge is big enough, it will ionize the air molecules between the objects. The charge can then travel through the ionized air. This is what we call a spark.

**The Electrophorus:** The electrophorus is a wonderful device that was invented by Alessandro Volta in 1775. He called it the *elettrofore perpetuo*. It seemed to an almost endless source of charge.

The electrophorus has two parts: a base made from an insulator and a metal plate that has an insulated handle.

Here's how to use the electrophorus.

1. The first step is to charge the insulator base by rubbing it with a cloth or fur. Then you, holding onto the insulated handle, place the metal plate onto the charged insulator base.
2. The metal plate will be polarized. Free electrons will collect on the upper surface of the metal plate.

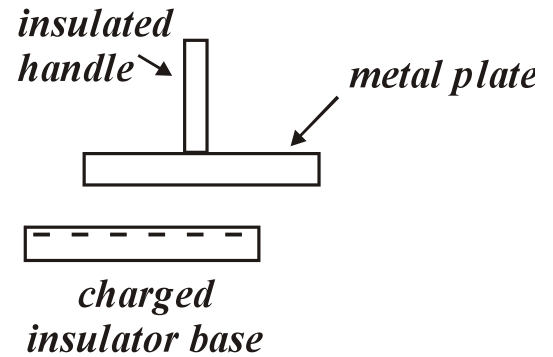
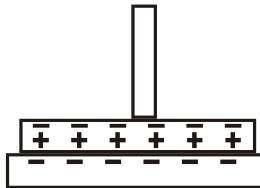

3. Touch the top surface of the metal plate with a finger while the plate sits on the base. Immediately remove your finger from the plate after the touch. You should feel a small spark. See, here's what happened, when you touched the plate, the free electrons had a path to ground and went into your finger. The plate now has a positive charge.

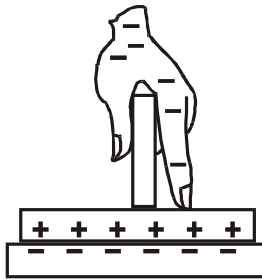

4. Pick the plate up with the handle. It is charged and you can transfer the charge to some other object.

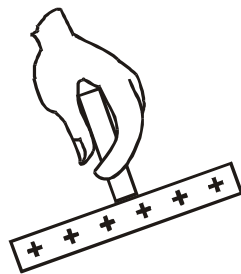

The plate did not remove any charge from the base, so if you place it on the base again, you can repeat the charging operation again and again. To the 18<sup>th</sup> century physicists, it seemed like a magical source of charge. Sadly, however, the charge on the insulated plate will eventually leak off into the air, so you can't use it forever. On a humid day, you might be lucky to charge the plate two or three times before the charge leaks off. This is because humid air ionizes much faster than does dry air.

**Electroscopes:** A useful device to measure charge is the electroscope. There are several different styles that are available. Each of them will indicate whether an object is charged.

**Foil on thread type:** One type is made from a small, light piece of metal foil that is attached to an insulated thread. A charged object is brought near the foil. The foil will be polarized and attracted to the charged object. When it touches the charged object it will be charged by conduction. Now having the same charge, it will be repelled.

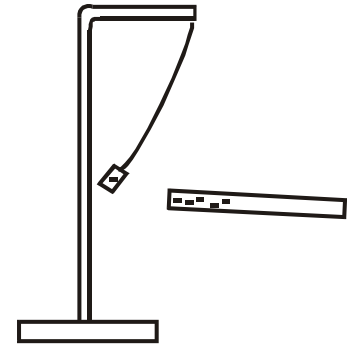

The angle formed by the thread with the vertical is proportional to the charge. If the foil is charged by a rubber rod, then one knows that it has a negative charge. An unknown charge can now be brought near the foil. If the charged foil is attracted, then you know that the object has a positive charge – remember, unlike charges attract. If the foil is repelled, then you know that the object has a negative charge – like charges repel.

**Twin hanging leaf type:** This type of electrostatic demonstrator is usually enclosed in a transparent box or beaker. A metal rod has a metal ball mounted on its top. We will call this the electrode. The rod goes into the box where it has two very thin metal foil leaves attached to it. The metal leaves hang downward and are separated by a small space. They are both attached to the rod.

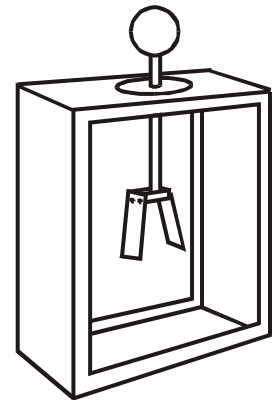

A negatively charged rod is brought to the electrode on the top. The electrode is charged by conduction. The charge travels throughout the rod and into the metal foil leaves. They each have a negative charge and will repel each other. This means that they will lift away from the vertical. The angle they make is proportional to the

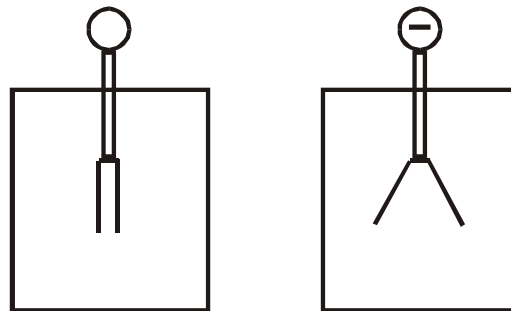

*No charge*

*Charged*

charge.

You charge up an electrophorus and give it a positive charge. You bring it to an electrostatic demonstrator to transfer the charge. How does a positive charge transfer?

As the electrophorus nears the ball on the electrode of the electrostatic demonstrator, the electrostatic demonstrator becomes polarized. Free electrons collect on the ball, attracted to the positive charge on the plate of the electrophorus.

The electrophorus has a pretty good charge, so usually the electrons will be so attracted to the plate as it nears that they will ionize the air and jump to the electrophorus in the form of a spark. The electrophorus is slightly less positive having collected some electrons and the electrostatic demonstrator is positive, having lost free electrons.

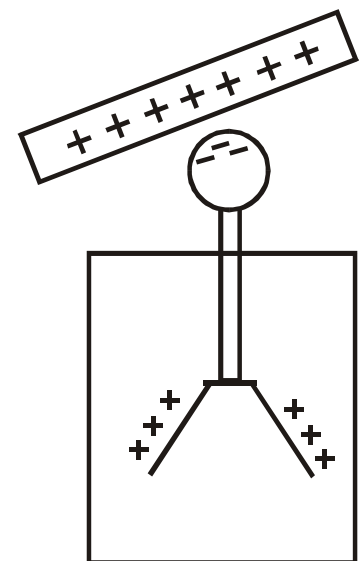

**Leyden Jar:** Ewald George von Kleist in 1745 and Pieter van Musschenbroek in 1746 developed this wonderful device. It was the first method discovered to store a significant amount of charge for later use. The Leyden jar was an accidental discovery. Kleist apparently thought that electricity was a liquid. It made sense that it might dissolve in water, so an attempt was made to put some charge in a beaker of water. He hooked a wire in the beaker to an electrostatic generating machine. Holding the beaker in his hand, he cranked up the machine to generate charge. It turned out that electricity did go into the beaker, but it didn't dissolve into the water. This was discovered a bit later when an assistant touched the wire in the beaker while holding the outside of the thing and got a tremendous shock. The shock was so painful and shocking that Kleist gave up on the whole thing.

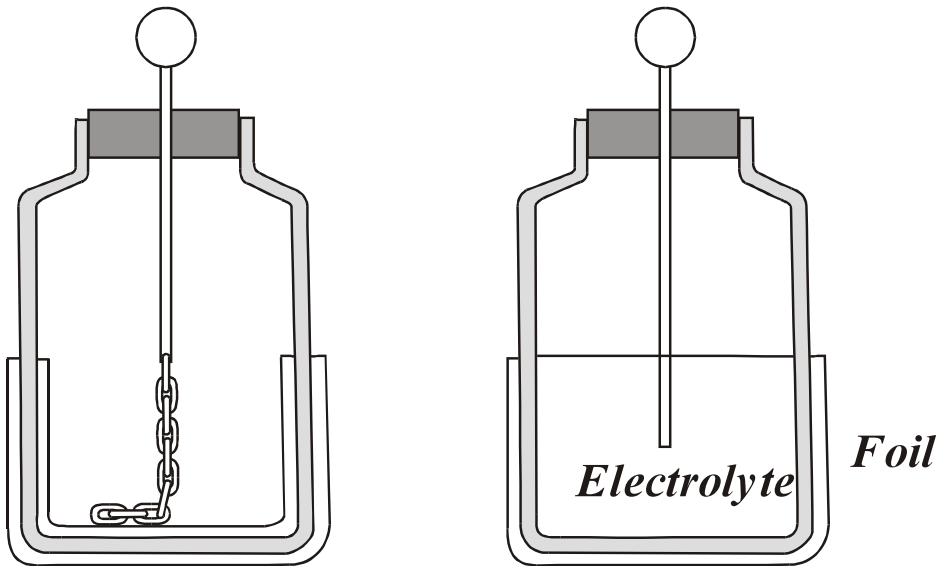

The Leyden jar was the first capacitor. The first one wasn't a real proper Leyden jar, but it certainly acted like one.

A Leyden jar is simply a jar that has a conductor on the inside lining its inner surface and a conductor on the outside surface. An electrode sticks up above the jar through the lid. The electrode is connected to the inner conductor.

Here is the classic Leyden jar. It has a metal foil lining on the inside lower half and a similar coating on the outside. The electrode in the center makes electrical contact with the inside metal layer via a chain.

The key thing though is that you must have two conductors separated by an insulator. Another common way to make a Leyden jar (the one we will use) is to have an electrolyte solution on the inside and a foil lining on the outside. The electrode pokes down into the electrolyte. Recall that electrolytes are solutions that conduct electricity. We will use salt water.

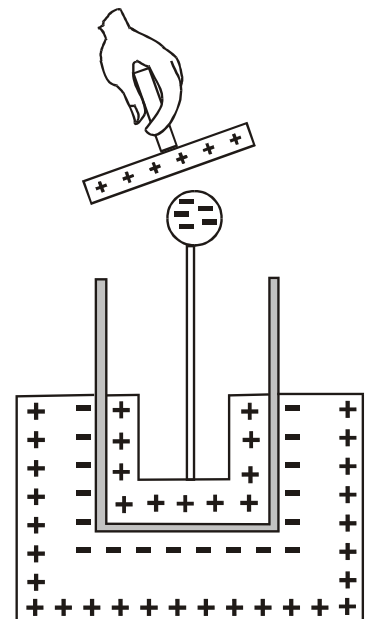

**Polarized  
Leyden jar**

**Charge and the Leyden Jar:** When a charged object is brought near the center electrode, the inner conductor becomes polarized. In the drawing (which has a greatly exaggerated conductor



thickness), a positive charge is brought near the electrode. The free electrons flow to the top ball, attracted by the positive charge. The inner conductor has a positive charge because the free electrons have made their departure. The outer conductor is also polarized. Just across the insulator is a strong positive charge, so the free electrons are attracted to the surface of the insulator.

To charge the Leyden jar, the outside conductor must be grounded as the charged object is brought to the electrode ball. Usually the charge will jump to the electrode in a spark.

If the outside of the jar isn't grounded, you can't store charge in the jar.

The grounding is usually done by holding the jar in you hand.

With a ground (your hand) attached to the outer conductor, electrons flow from the ground into the outer conductor. The free electrons at the top of the electrode flow into the positively charged object. You end up with a negative charge on the outer conductor and a positive charge on the inner conductor. They stay in place because they attract each other across the insulator. You can pick it up by the outer conductor and the charge stays in place.

This is how the Leyden jar stores charge.

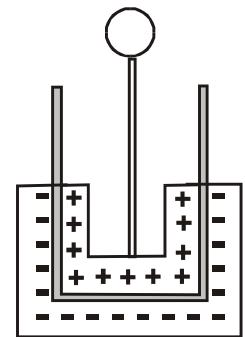

***Charged  
Leyden jar***

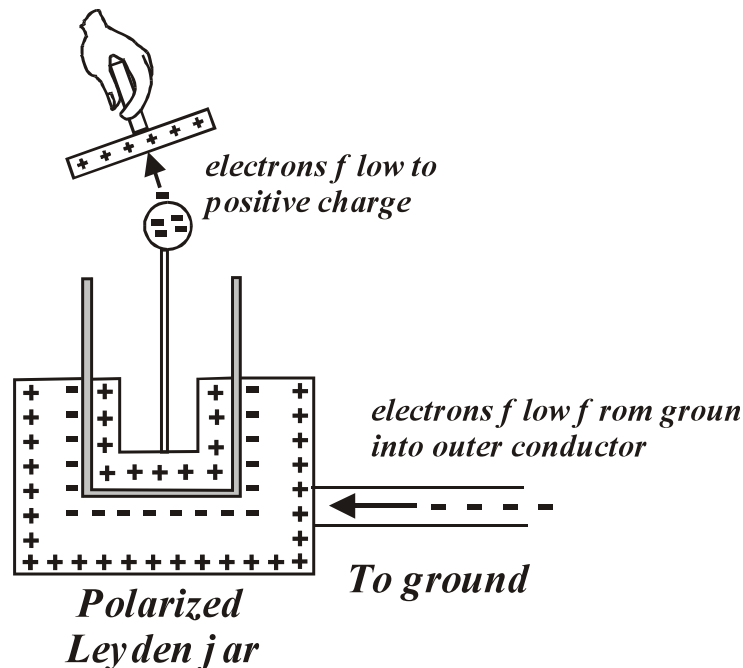

***Polarized  
Leyden jar***